

RISERVATO

SU PREZZI

DI LISTINO 12%

MPP (MP)



MOTORE "M+S HYDRAULIC"
"M+S HYDRAULIC" MOTOR
MOTOR "M+S HYDRAULIC"

ALBERO CILINDRICO Ø25
PARALLEL SHAFT Ø25
ZYLINDRISCHE WELLE Ø25

FLANGIA "SAE A" - 2 FORI
"SAE A" FLANGE - 2 HOLES
FLANSCH "SAE A" - 2 BOHRUNGEN

Standard: CONNESSIONI LATERALI - SIDE PORTS - ANSCHLÜSSE SEITLICH

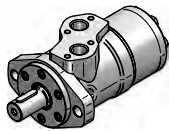

PREDISPOSTO PER IL DRENAGGIO
MACHINED FOR DRAIN CONNECTION
FÜR DRÄNLEITUNG GEEIGNET

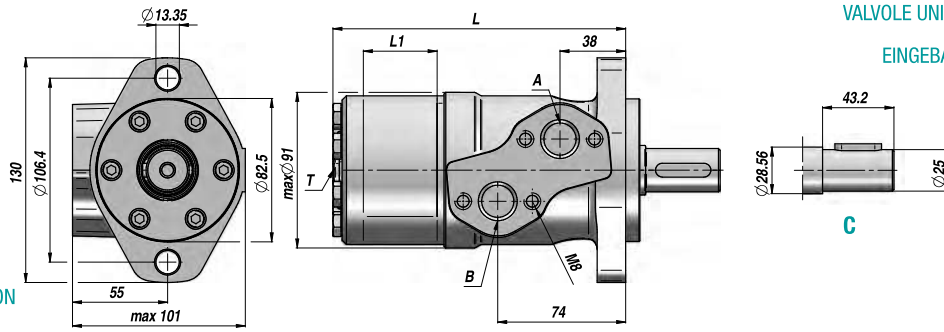

VALVOLE UNIDIREZIONALI INCORPORATE
BUILT-IN CHECK VALVES
EINGebaUTE RÜCKSCHLAGVENTILE

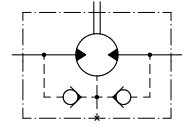

Codice Code Bestell-Nr.	Tipo Type Typ	cm³/giro cm³/rev cm³/U	n. Max giri/min rpm - U/Min.	M Max daNm	Q MAX l/min	P MAX bar			A - B	T	L	L1	kg
						Caduta Drop Gefälle Δp	Ingresso Inlet Eingang	Ritorno Return Rücklauf					
LAVORO CONTINUO - CONTINUOUS WORK - DAUERARBEIT													
MSP025NC25**	MPP 25 CD	25,0	1600	3,3	40	100	175	175 *			134	5,20	5,60
MSP032NC25**	MPP 32 CD	32,0	1560	4,3	50	100	175	175 *			135	6,30	5,60
MSP040NC25**	MPP 40 CD	40,0	1500	6,2	60	120	175	175 *			136,5	7,40	5,70
MSP050NC25	MPP 50 C	49,5	1210	9,4	60	140	175	175 *			135,5	6,67	5,80
MSP080NC25	MPP 80 C	79,2	755	15,1	60	140	175	175 *			139,5	10,67	5,90
MSP100NC25	MPP 100 C	99,0	605	19,3	60	140	175	175 *			142	13,33	6,10
MSP125NC25	MPP 125 C	123,8	486	23,7	60	140	175	175 *	1/2"	1/4"	145,5	16,67	6,20
MSP160NC25	MPP 160 C	158,4	378	31,3	60	140	175	175 *			150	21,33	6,40
MSP200NC25	MPP 200 C	198,0	303	36,6	60	140	175	175 *			155,5	26,67	6,60
MSP250NC25	MPP 250 C	247,5	242	38,0	60	110	175	175 *			162	33,33	6,80
MSP315NC25	MPP 315 C	316,8	190	38,0	60	90	175	175 *			171,5	42,67	7,10
MSP400NC25	MPP 400 C	396,0	150	36,0	60	70	175	175 *			182	53,33	7,60
MSP500NC25	MPP 500 C	495,0	120	39,0	60	140	140 *	140 *			195,5	66,63	8,90
MSP630NC25	MPP 630 C	623,6	95	44,0	60	55	140	140 *			213	84,00	9,50

* = CON DRENAGGIO - WITH DRAIN - MIT DRÄNLEITUNG

** Solo Versione "D" - "D" Version only - Nur Version "D" (vedi grafico - see diagram - siehe Diagramm)

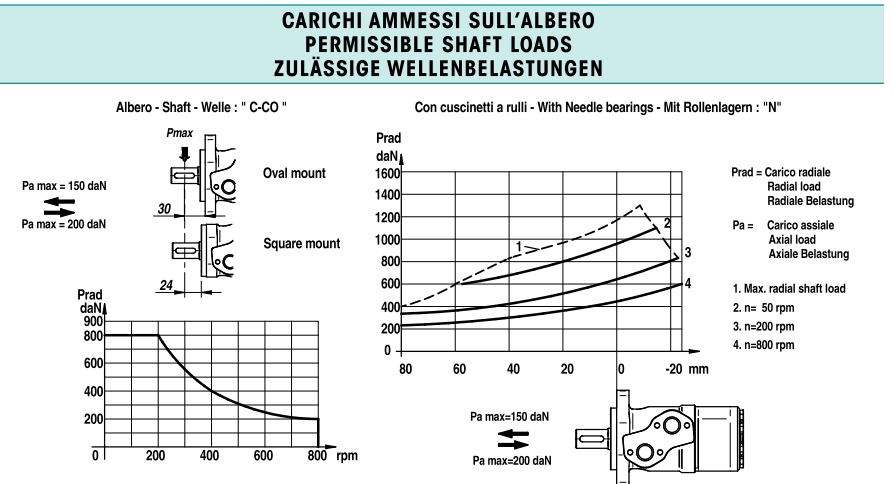
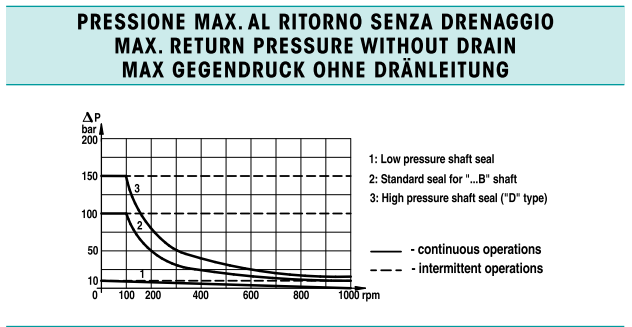
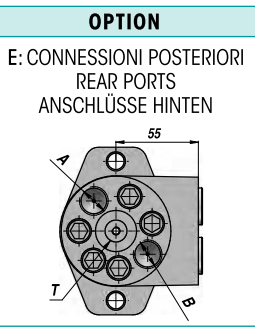
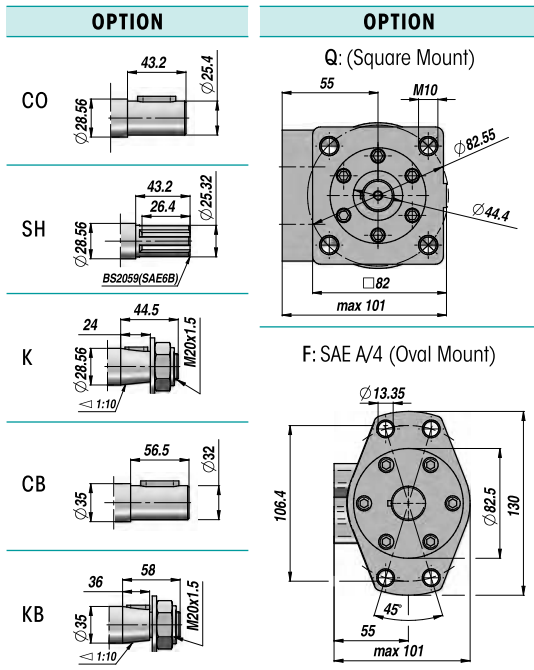

VERSIONI SPECIALI - SPECIAL VERSIONS - SPEZIELLE VERSIONEN
D: guarnizione albero - shaft seal - Wellendichtung: max 150 bar
N/D: con cuscinetti a rulli - with needle bearings - mit Rollenlagern
W: versione ruota - wheel mount - Radversion

MOTORI ORBITALI

MCM

MOTORE "Z-J HYDRAULIC" ALBERO
CILINDRICO Ø16 CONNESSIONI
POSTERIORI



MCMS

MOTORE "Z-J HYDRAULIC" ALBERO
CILINDRICO Ø16 CONNESSIONI
LATERALI

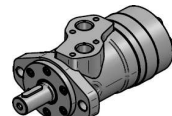

MCPN

MOTORE "Z-J HYDRAULIC" ALBERO
CILINDRICO Ø25
FLANGIA "SAE A" - 2 FORI

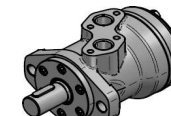

MCRN

MOTORE "Z-J HYDRAULIC" ALBERO
CILINDRICO Ø25
FLANGIA "SAE A" - 2 FORI

CODICE	TIPO	Listino	Sc	Netto
MCM00008C0	MC-M 08 C	164,20	0	164,20
MCM00012C0	MC-M 12 C	164,25	0	164,25
MCM00020C0	MC-M 20 C	167,85	0	167,85
MCM00032C0	MC-M 32 C	171,55	0	171,55
MCM00040C0	MC-M 40 C	175,25	0	175,25
MCM00050C0	MC-M 50 C	182,60	0	182,60

CODICE	TIPO	Listino	Sc	Netto
MCM00S08C0	MC-MS 08 C	164,20	0	164,20
MCM00S12C0	MC-MS 12 C	164,25	0	164,25
MCM00S20C0	MC-MS 20 C	167,85	0	167,85
MCM00S32C0	MC-MS 32 C	171,55	0	171,55
MCM00S40C0	MC-MS 40 C	175,25	0	175,25
MCM00S50C0	MC-MS 50 C	182,60	0	182,60

CODICE	TIPO	Listino	Sc	Netto
MCPN036C00	MC-PN 36 CD	179,20	0	179,20
MCPN050C00	MC-PN 50 CD	179,20	0	179,20
MCPN080C00	MC-PN 80 CD	182,90	0	182,90
MCPN100C00	MC-PN 100 CD	186,65	0	186,65
MCPN125C00	MC-PN 125 CD	190,30	0	190,30
MCPN160C00	MC-PN 160 CD	194,05	0	194,05
MCPN200C00	MC-PN 200 CD	199,65	0	199,65
MCPN250C00	MC-PN 250 CD	203,35	0	203,35
MCPN315C00	MC-PN 315 CD	212,60	0	212,60
MCPN400C00	MC-PN 400 CD	216,55	0	216,55
MCPN500C00	MC-PN 500 CD	236,15	0	236,15

CODICE	TIPO	Listino	Sc	Netto
MCRN036C00	MC-RN 36 CD	215,05	0	215,05
MCRN050C00	MC-RN 50 CD	215,05	0	215,05
MCRN080C00	MC-RN 80 CD	218,95	0	218,95
MCRN100C00	MC-RN 100 CD	222,60	0	222,60
MCRN125C00	MC-RN 125 CD	226,55	0	226,55
MCRN160C00	MC-RN 160 CD	232,40	0	232,40
MCRN200C00	MC-RN 200 CD	240,10	0	240,10
MCRN250C00	MC-RN 250 CD	242,25	0	242,25
MCRN315C00	MC-RN 350 CD	246,30	0	246,30
MCRN400C00	MC-RN 400 CD	255,00	0	255,00

MCSY

MOTORE "Z-J HYDRAULIC" ALBERO
CILINDRICO Ø32
FLANGIA "SAE A" - 4 FORI

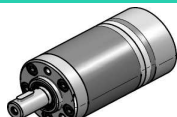

MPM (MM)

MOTORE "M+S HYDRAULIC" ALBERO
CILINDRICO Ø16 SENZA FLANGIA

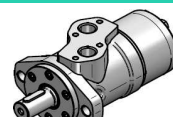

MPP (MP)

MOTORE "M+S HYDRAULIC" ALBERO
CILINDRICO Ø25
FLANGIA "SAE A" - 2 FORI

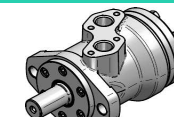

MPR (MR)

MOTORE "M+S HYDRAULIC" ALBERO
CILINDRICO Ø25
FLANGIA "SAE A" - 2 FORI

CODICE	TIPO	Listino	Sc	Netto
MCSY080C00	MC-SY 80 C	363,50	0	363,50
MCSY100C00	MC-SY 100 C	375,05	0	375,05
MCSY125C00	MC-SY 125 C	379,00	0	379,00
MCSY160C00	MC-SY 160 C	386,90	0	386,90
MCSY200C00	MC-SY 200 C	394,70	0	394,70
MCSY250C00	MC-SY 250 C	398,85	0	398,85
MCSY315C00	MC-SY 315 C	425,90	0	425,90
MCSY400C00	MC-SY 400 C	441,30	0	441,30
MCSY475C00	MC-SY 475 C	465,20	0	465,20

CODICE	TIPO	Listino	Sc	Netto
MPM008NC16	MPM 8 C	198,95	0	198,95
MPM012NC16	MPM 12 C	202,25	0	202,25
MPM020NC16	MPM 20 C	205,60	0	205,60
MPM032NC16	MPM 32 C	208,95	0	208,95
MPM040NC16	MPM 40 C	223,35	0	223,35
MPM050NC16	MPM 50 C	249,80	0	249,80

CODICE	TIPO	Listino	Sc	Netto
MSP025NC25	MPP 25 CD	242,20	0	242,20
MSP032NC25	MPP 32 CD	244,45	0	244,45
MSP040NC25	MPP 40 CD	245,95	0	245,95
MSP050NC25	MPP 50 C	228,70	0	228,70
MSP080NC25	MPP 80 C	235,40	0	235,40
MSP100NC25	MPP 100 C	239,80	0	239,80
MSP125NC25	MPP 125 C	246,50	0	246,50
MSP160NC25	MPP 160 C	253,20	0	253,20
MSP200NC25	MPP 200 C	262,05	0	262,05
MSP250NC25	MPP 250 C	268,70	0	268,70
MSP315NC25	MPP 315 C	275,35	0	275,35
MSP400NC25	MPP 400 C	286,50	0	286,50
MSP500NC25	MPP 500 C	353,65	0	353,65
MSP630NC25	MPP 630 C	414,90	0	414,90

CODICE	TIPO	Listino	Sc	Netto
MSR050NC25	MPR 50 C	294,50	0	294,50
MSR080NC25	MPR 80 C	303,10	0	303,10
MSR100NC25	MPR 100 C	308,75	0	308,75
MSR125NC25	MPR 125 C	317,45	0	317,45
MSR160NC25	MPR 160 C	326,00	0	326,00
MSR200NC25	MPR 200 C	337,40	0	337,40
MSR250NC25	MPR 250 C	346,00	0	346,00
MSR315NC25	MPR 315 C	354,60	0	354,60
MSR400NC25	MPR 400 C	368,90	0	368,90

MPS (MS)

MOTORE "M+S HYDRAULIC" ALBERO
CILINDRICO Ø32
FLANGIA "SAE A" - 4 FORI

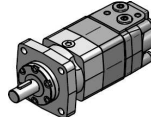

MPT (MT)

MOTORE "M+S HYDRAULIC" ALBERO
CILINDRICO Ø40
FLANGIA QUADRA - 4 FORI

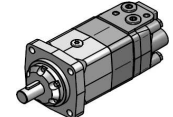

MPV (MV)

MOTORE "M+S HYDRAULIC" ALBERO
CILINDRICO Ø50
FLANGIA QUADRA - 4 FORI

CODICE	TIPO	Listino	Sc	Netto
MPS080NC32	MPS 80 C	500,55	0	500,55
MPS100NC32	MPS 100 C	506,50	0	506,50
MPS125NC32	MPS 125 C	515,25	0	515,25
MPS160NC32	MPS 160 C	527,05	0	527,05
MPS200NC32	MPS 200 C	535,85	0	535,85
MPS250NC32	MPS 250 C	544,70	0	544,70
MPS315NC32	MPS 315 C	577,05	0	577,05
MPS400NC32	MPS 400 C	606,50	0	606,50
MPS475NC32	MPS 475 C	796,35	0	796,35
MPS525NC32	MPS 525 C	811,05	0	811,05
MPS565NC32	MPS 565 C	825,75	0	825,75

CODICE	TIPO	Listino	Sc	Netto
MPT160NC40	MPT 160 C	886,20	0	886,20
MPT200NC40	MPT 200 C	905,15	0	905,15
MPT250NC40	MPT 250 C	933,95	0	933,95
MPT315NC40	MPT 315 C	958,00	0	958,00
MPT400NC40	MPT 400 C	996,25	0	996,25
MPT500NC40	MPT 500 C	1063,30	0	1063,30
MPT630NC40	MPT 630 C	1248,60	0	1248,60
MPT725NC40	MPT 725 C	1316,50	0	1316,50

CODICE	TIPO	Listino	Sc	Netto
MPV315C000	MPV 315 C	1275,95	0	1275,95
MPV400C000	MPV 400 C	1326,90	0	1326,90
MPV500C000	MPV 500 C	1416,10	0	1416,10
MPV630C000	MPV 630 C	1658,20	0	1658,20
MPV800C000	MPV 800 C	1747,45	0	1747,45